



DESIGN

- All forgings and pins are made in the USA to insure consistency of the steel base material
- Brookline High Abuse Hinges are drop forged for added strength and better weldability
- All hinge pins are case hardened for greater durability
- All Hinge pins are black oxide coated for better corrosion resistance
- All Hinge Pins are mechanically pressed into a blind hold to prevent disassembly of the hinge
- An External Lubrication point is provided in the knuckle
- A 400 series stainless steel hinge pin is available for greater corrosion resistance
- Brookline heavy and medium duty steel based "high abuse hinges" meet the "Buy America Act"

PERFORMANCE

- Each Heavy Duty Hinge contains two internal heavy duty thrust bearings with hardened steel ball bearings to support greater weight and provide a smooth, consistent operation
- All Steel based hinges are primed with rust inhibitor and are ready to accept paint in the field.

SECURITY

- All Brookline High Abuse Template Hinges are provided with Break Away Head security Screws to prevent removal once the hinge is installed
- Brookline Hospital Tip High Abuse Hinges are provided with stainless steel security screws
- All hinge pins are case hardened for greater security and to deter tampering
- Brookline Hospital Tip High Abuse Hinges are provided with stainless steel security screws
- All hinge pins are mechanically pressed into a blind hole to prevent removal after the hinge is assembled. A welded hinge pin is available
- All Brookline high abuse heavy hinges can be welded into place

INSTALLATION

- Brookline Hinges can be installed by template or by welding in place
- Brookline hinges are available in different leaf lengths to accommodate various door, wall and jamb conditions
- All High Abuse hinges are supplied with break-away head security screws
- Brookline High Abuse hinges are non handed

O-2 MODEL No.

Description

5X400D

**Heavy Duty Hinge
(Non Handed)**

Doors with 2 Hinges

Weight to 500lbs (226)kg

Doors with 3 Hinges

Weight to 750lbs (342)kg

- Heavy Weight Surface Mounted Hinge for High Abuse Applications
- 1/2" (12.7)mm Thick Heavy Duty Steel Leaves
- 3/4" (19.1)mm Hardened Steel Pin Knurled and Pressed Into Blind Hole
- Internal Thrust Bearings with Hardened Steel Ball Bearings
- External Lubrication Point Provided in Knuckle
- Supplied with 1/2"-13 x 1" Steel Security Screws with Break Away Head
- Supplied in Prime Coat Finish. Special Finishing Available on Request

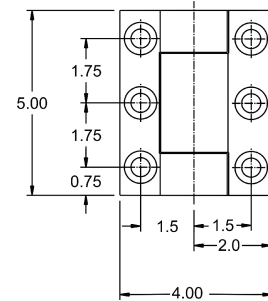
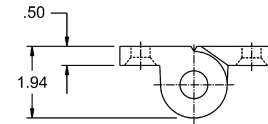
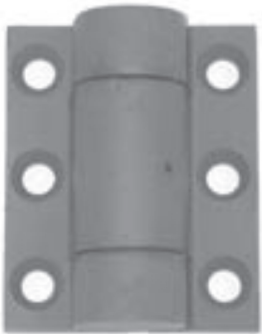

- This Product Meets Buy America
- Welded Pin Construction or Non Standard Hole Patterns Available on Request

5X400B

**Heavy Duty Hinge
(Non Handed)**

Doors with 2 Hinges (Welded)

Weight to 1000lbs (452)kg

Doors with 3 Hinges (Welded)

Weight to 2000lbs (904)kg

- Heavy Weight Surface Mounted Hinge for High Abuse Applications
- 1/2" (12.7)mm Thick Heavy Duty Steel Leaves
- 3/4" (19.1)mm Hardened Steel Pin Knurled and Pressed Into Blind Hole
- Internal Thrust Bearings with Hardened Steel Ball Bearings
- External Lubrication Point Provided in Knuckle
- Blank Leaves Without Holes for Welded Applications
- Supplied in Prime Coat Finish. Special Finishing Available on Request

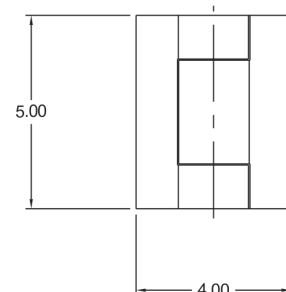
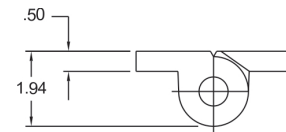
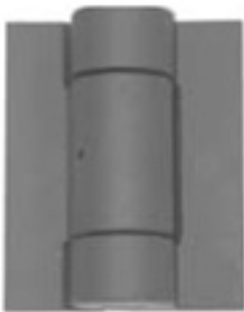

- This Product Meets Buy America
- Welded Pin Construction or Non Standard Hole Patterns Available on Request

MODEL No.	Description	O-3
-----------	-------------	-----

5X525D

**Heavy Duty Hinge
(Non Handed)**

Doors with 2 Hinges

Weight to 500lbs (226)kg

Doors with 3 Hinges

Weight to 750lbs (342)kg

Weight to 750lbs (342)kg

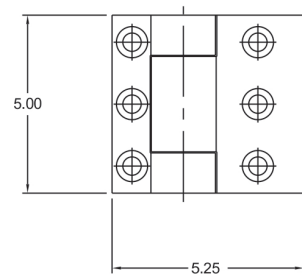
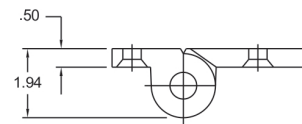

- This Product Meets Buy America
- Welded Pin Construction or Non Standard Hole Patterns Available on Request

5X525B

**Heavy Duty Hinge
(Non Handed)**

Doors with 2 Hinges (Welded)

Weight to 1000lbs (452)kg

Doors with 3 Hinges (Welded)

Weight to 2000lbs (904)kg

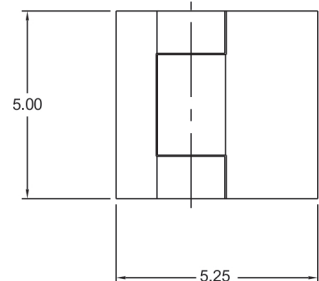
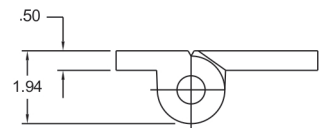

- This Product Meets Buy America
- Welded Pin Construction or Non Standard Hole Patterns Available on Request

O-4 MODEL No.

Description

5X650C (Custom)

Heavy Duty Hinge

Hole Patterns Per Specification

Doors with 2 Hinges

Weight to 500lbs (226)kg

Doors with 3 Hinges

Weight to 750lbs (342)kg

- Heavy Weight Surface Mounted Hinge for High Abuse Applications
- 1/2" (12.7)mm Thick Heavy Duty Steel Leaves
- 3/4" (19.1)mm Hardened Steel Pin Knurled and Pressed Into Blind Hole
- Internal Thrust Bearings with Hardened Steel Ball Bearings
- External Lubrication Point Provided in Knuckle
- Supplied with 1/2"-13 x 1" Steel Security Screws with Break Away Head
- Supplied in Prime Coat Finish. Special Finishing Available on Request

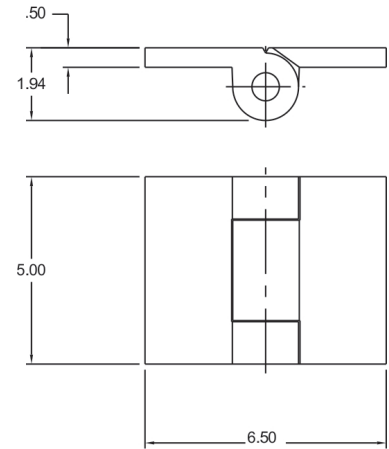

- This Product Meets Buy America
- Welded Pin Construction or Non Standard Hole Patterns Available on Request

5X650B

Heavy Duty Hinge (Non Handed)

Doors with 2 Hinges (Welded)

Weight to 1000lbs (452)kg

Doors with 3 Hinges (Welded)

Weight to 2000lbs (904)kg

- Heavy Weight Surface Mounted Hinge for High Abuse Applications
- 1/2" (12.7)mm Thick Heavy Duty Steel Leaves
- 3/4" (19.1)mm Hardened Steel Pin Knurled and Pressed Into Blind Hole
- Internal Thrust Bearings with Hardened Steel Ball Bearings
- External Lubrication Point Provided in Knuckle
- Blank Leaves Without Holes for Welded Applications
- Supplied in Prime Coat Finish. Special Finishing Available on Request

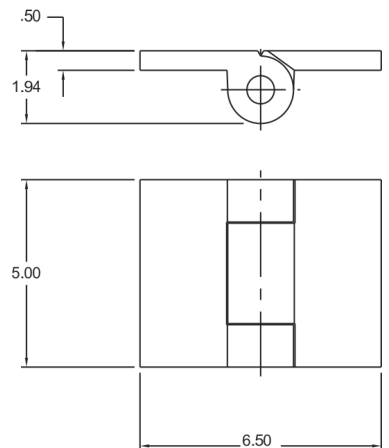

- This Product Meets Buy America
- Welded Pin Construction or Non Standard Hole Patterns Available on Request



MODEL No.	Description	O-5
-----------	-------------	-----

3X400D

Standard Duty Utility Hinge

Doors with 2 Hinges

Weight to 150lbs (68.2)kg

- Standard Duty Investment Cast Steel
- Surface Mounted for Abusive Applications
- 3/8" (9.5)mm Thick Heavy Duty Steel Leaves
- 3/8" (9.5)mm Hardened Steel Pin Knurled and Pressed Into Blind Hole
- External Lubrication Point Provided in Knuckle
- Supplied with 3/8"-16 x 3/4" Steel Security Screws with Break Away Head
- Supplied In Prime Coat Finish. Special Finishes on Request

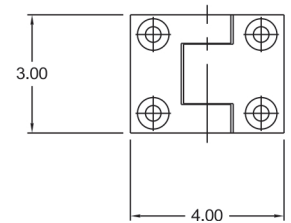
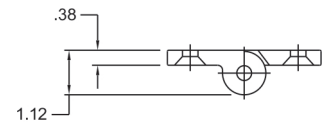

- This Product Meets Buy America
- Welded Pin Construction or Non Standard Hole Patterns Available on Request
- Non Standard Hole Patterns On Request

THHT4545-32D

Heavy Hospital Tip Hinge (Non Handed)

Doors with 2 Hinges

Weight to 150lbs (68.2)kg

Door With 3 Hinges

Weight to 300lbs (136.4)kg

- Full Mortise Investment Cast Satinless Steel Template Hinge
- Concealed Maintenance Free Bearing
- Hardened Free Turning Concealed Pin
- Intergral Anti Shear Security Stud and Hospital Tips
- Supplied with 3/8"-16 x 3/4" Steel Security Screws
- Supplied in Brushed Stainless Steel US 32D

